



Rubidium™

Low Noise RF/Microwave Signal Generator

MG362x1A

9 kHz to 20/43.5/70 GHz

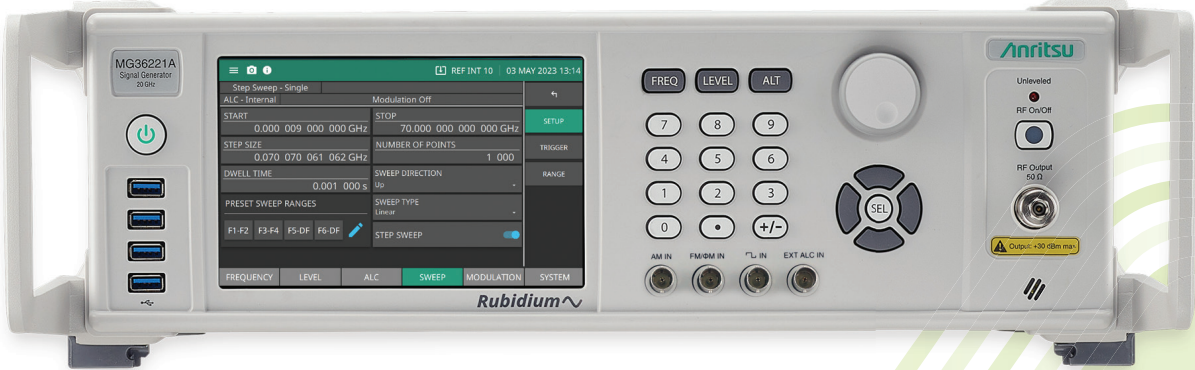

OVERVIEW

Signal purity, output power and frequency stability are core performance metrics that mark excellence of any RF/Microwave signal generator. Anritsu's new Rubidium MG362x1A signal generator product line pushes the performance envelope of signal purity, frequency stability, and output power to new levels that are unmatched in the industry. Its built-in, easy-to-use, at location frequency calibration capability offers great value and overall utility to customers. With Anritsu's proven record of high-reliability and long-term support, Rubidium MG362x1A signal generators are the best choice for a wide range of measurement applications.

Key Features

- Extended Frequency coverage from 9 kHz to 70 GHz with best in class output power
- Exceptionally low single sideband SSB phase noise of -136 dBc/Hz (typical) and -140 dBc/Hz (measured) at 10 GHz and 10 kHz offset
- Very low harmonic of < -58 dBc and spurious < -63 dBc
- Atomic clock frequency stability of $< 8.0 \times 10^{-12}$ Allan deviation (over 100 sec), aging rate $< 1 \times 10^{-9}$ per year, with T&M grade phase noise
- Comprehensive modulation capability that includes AM, FM, PM, Pulse, and Pulse train
- Arbitrary waveform generation and simultaneous synchronized FM and Pulse modulation (for generating chirps)
- Analog frequency sweep with up to 20 independent markers (for MG36221A and MG36241A only)
- Optional on-site frequency calibration capability integrated (requires Option 66)
- Removable SDIO memory card slot that supports memory devices up to 8 GB
- Wide range of interfaces for remote control such as 6 x USB 3.0, 1 x 10/100/1000 Ethernet, 1 x GPIB
- Industry standard IVI.NET and IVI-C drivers and SCPI support for remote instrument control
- Easy to navigate GUI that supports a new 7-inch touch screen and traditional front panel keypad/dial

Best in Class Output Power

For accurate nonlinear measurements it is important for a signal generator to have adequately high output power particularly at microwave and mmWave frequencies. Characterizing devices and microwave subsystems in nonlinear region provides valuable insight about how multiple signals interact and create additional components. High enough output power from signal generator is essential in order to push devices and systems in to non linear region during characterization.

The Rubidium MG362x1A signal generator features best in class output power, all the way up to 70 GHz and beyond, while still maintaining low harmonics.

1. All Rubidium MG362x1A standard models offer industry's highest output power. Most signal generators in the market would be compelled to add a high power option in order to match Rubidium's standard output power, resulting in additional cost for users. Hence Rubidium standard output power offers the best value to its users compared to competition.

Rubidium MG362x1A

OVERVIEW

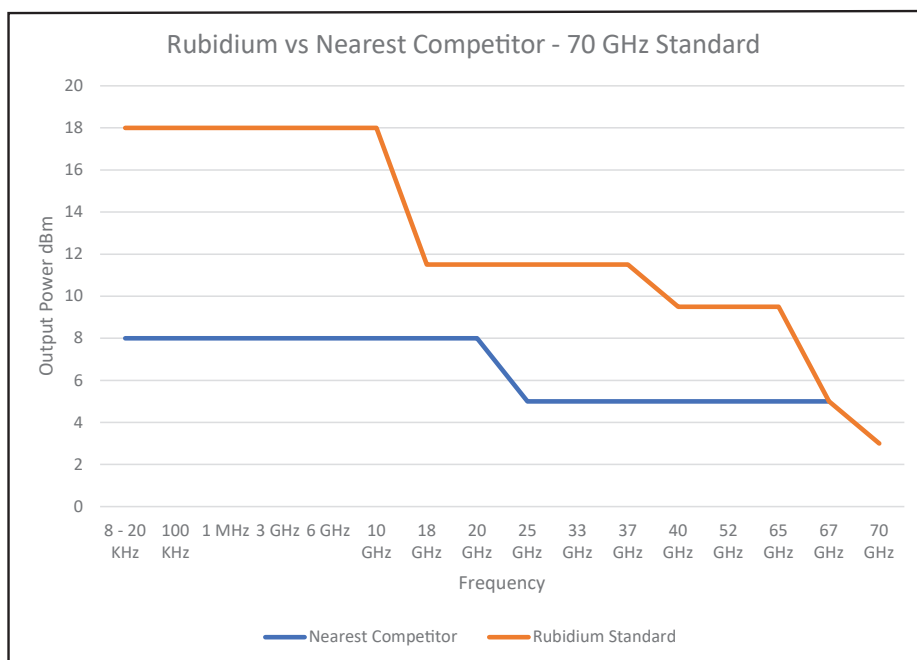
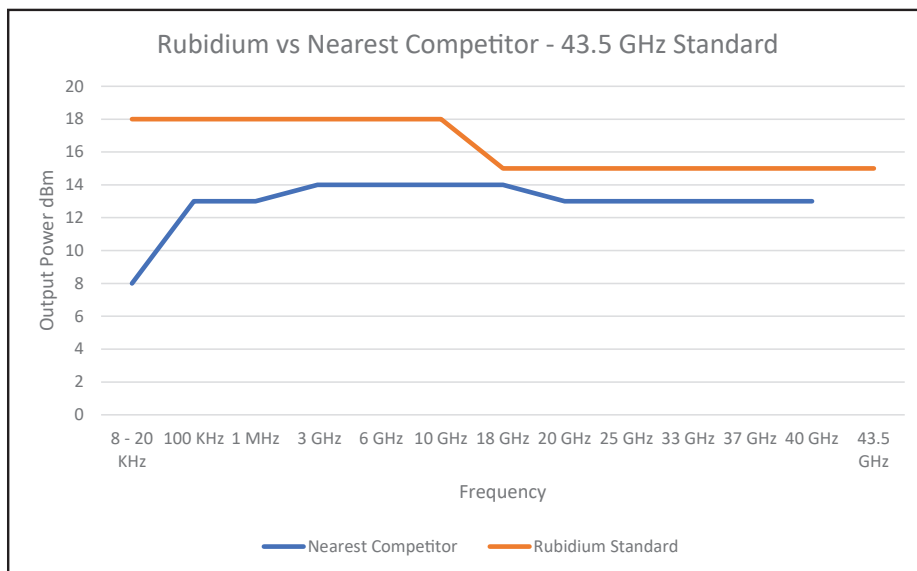
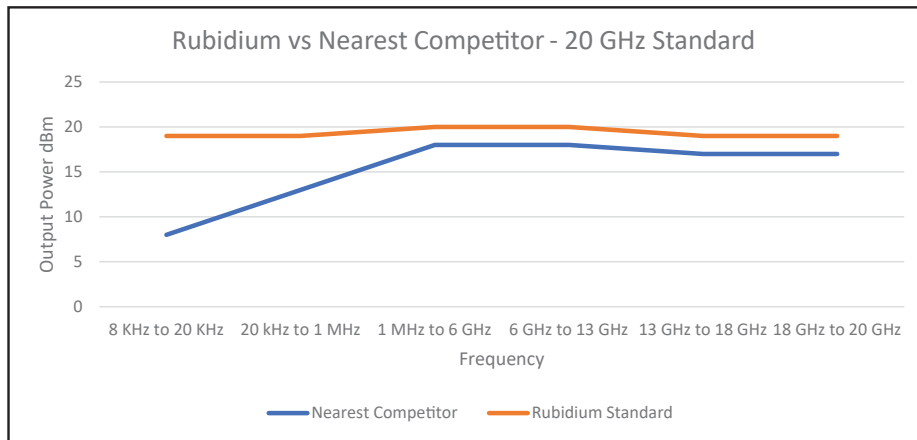

OVERVIEW

2. For users who require higher output power, Rubidium offers a High Power Option (Option 15). With the high power option, users can get 3 dB to 8 dB higher output power than standard output power. Higher output power is very helpful at microwave frequencies because it can overcome higher cable losses without any need for an external amplifier.
3. Nonlinear measurements employ signals at power levels high enough that can put devices or subsystems under test into non linear operating mode. For that reason these signals can also be close to device damage levels and there is an increased risk of damaging the device under test. In order to prevent possibility of inadvertently damaging device under test, Rubidium provides capability called "RF LEVEL LIMIT" which limits output power to a level that can be set by the user. Once the limit is set, Rubidium's output power will never exceed limits both in CW mode and sweep mode.

Outstanding Signal Purity

SSB Phase noise is the most important measure of signal purity in a signal generator. Phase noise of the standard Rubidium MG362x1A signal generator outperforms phase noise offered by most signal generators in the market today with a robust margin. Additionally, the Rubidium MG362x1A offers two low phase noise options which provide performance that is unmatched in the market:

1. Low Phase Noise (Option 3): This option enhances close in phase noise (< 1 kHz) performance and frequency stability of the Rubidium MG362x1A standard unit. Low close in phase noise is critical in many measurement applications such as testing Doppler radars that detect very slow moving targets.
2. Ultra Low Phase Noise (Option 13): This option offers the best phase noise across the entire range of offsets from 10 Hz to 100 MHz. Phase noise across the entire range of offsets yields superior integrated phase noise which is important when the signal generator is used as a local oscillator (LO) source for testing up/down converters or when used as a clock source to test ADCs/DACs.

In addition to the two low phase noise options, for CW only applications between 2 GHz to 20 GHz, Rubidium's Option 23 provides an even lower phase noise. The ultra low phase noise option achieves a ground breaking -140 dBc/Hz at 10 GHz and 10 kHz offset.

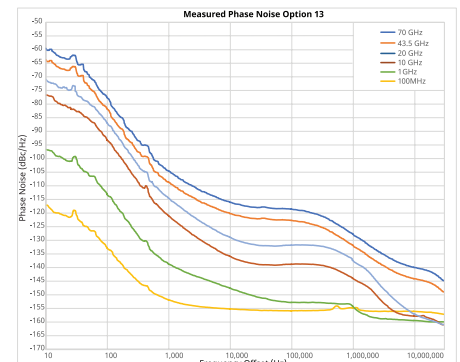
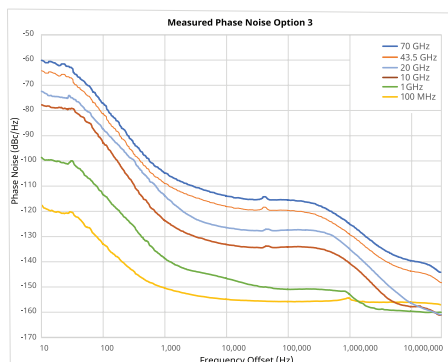
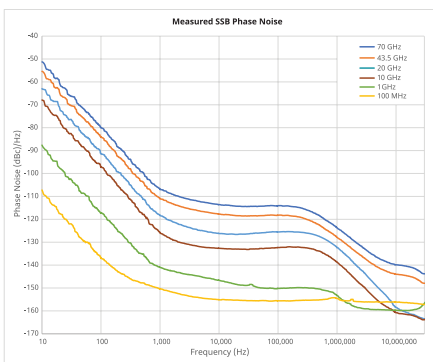

Atomic Clock Timebase and Frequency Stability

Frequency stability and accuracy of a signal generator are critical in many measurement applications. The Rubidium MG362x1A signal generator offers two options that provide order-of-magnitude and better frequency stability and accuracy than a typical oven controlled crystal (OCXO) reference.

1. Ultra Stability Timebase (Option 56): This option adds an internal rubidium clock timebase that provides exceptional medium and long term frequency stability while still maintaining T&M grade phase noise. With an order-of-magnitude lower aging rate than a typical OCXO, rubidium clock reference can provide much better frequency accuracy.
2. GNSS/GPS Atomic Clock Receiver (Option 66): This option adds an internal GNSS/GPS atomic clock receiver. The receiver generates an accurate one pulse per sec (1 PPS) signal when connected to a GNSS/GPS satellite signal which is used to calibrate the signal generator's internal OCXO or a rubidium clock time base.

Parameter	Rubidium with Option 56	Sig Gen with OCXO Ref
Aging rate per day	$< \pm 2 \times 10^{-11}$	$< \pm 5 \times 10^{-10}$
Aging rate per year	$< \pm 1 \times 10^{-9}$	$< \pm 3 \times 10^{-8}$
Temperature effects from 0 to +55 °C	$< \pm 3 \times 10^{-10}$	$< \pm 3 \times 10^{-9}$
Short-term stability (Allan deviation) per 100 s	$< \pm 8 \times 10^{-12}$	NA

Options 56 and 66 are ideal for signal generator applications in metrology and calibration labs, astronomy research, and satellite ground stations as shown in Figure 1. Option 56 (rubidium clock) is well suited for defense applications that require a very stable and independent reference not tied to a GPS/GNSS signal (see Figure 2).

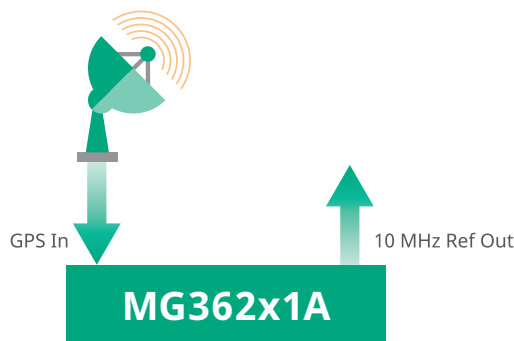

Figure 1. Sig Gen with GNSS/SPS Atomic Clock Receiver (Option 66)

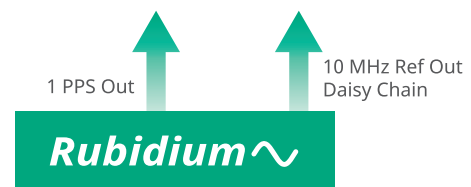
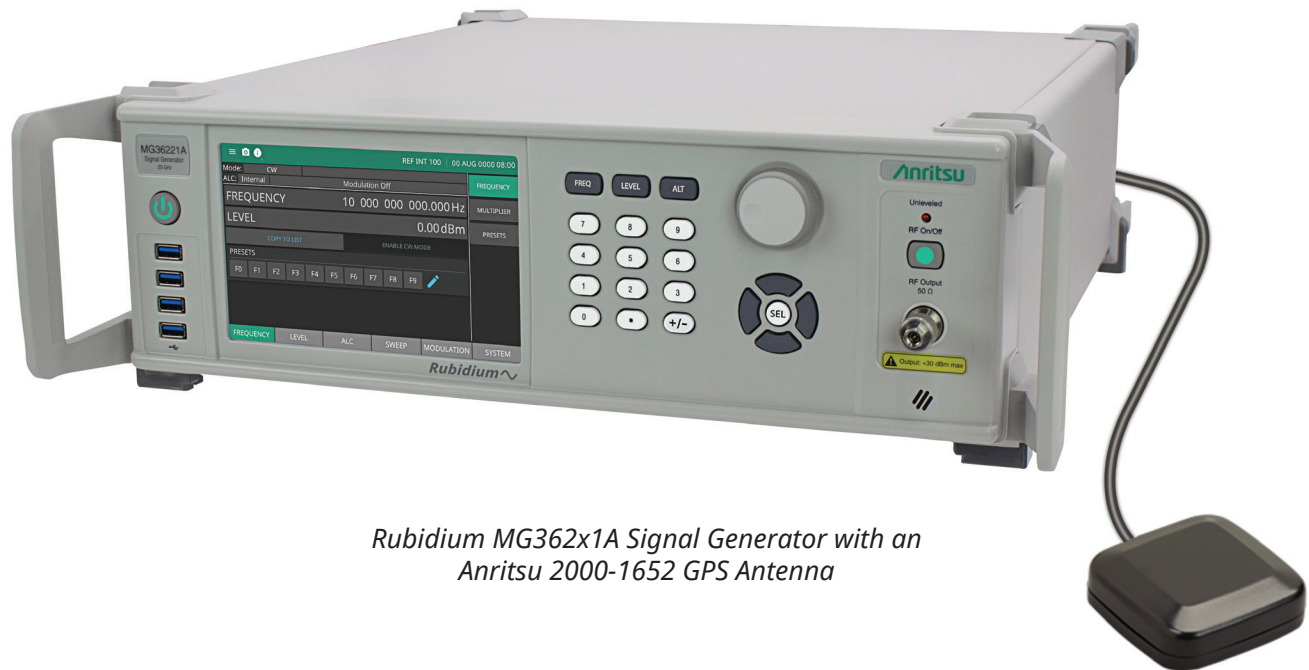

Figure 2. Rubidium Atomic Clock Reference

On-site Frequency Calibration

The Rubidium MG362x1A signal generator features on-site frequency calibration capability built in to the instrument. The on-site frequency calibration is accomplished at the touch of a button on the GUI interface. When customers want to ensure frequency accuracy of the instrument, it can be done without ever sending the instrument to a calibration lab. This saves time and cost for the customer and increases instrument availability.

On-site frequency calibration is accomplished by connecting the Rubidium MG362x1A signal generator's GNSS/GPS receiver to an outdoor antenna and locking to the satellite signal. The GNSS/GPS receiver provides a very stable and accurate 1PPS clock for recalibrating the internal time base.



*Rubidium MG362x1A Signal Generator with an
Anritsu 2000-1652 GPS Antenna*

Rubidium MG362x1A

On-site Level Calibration

The Rubidium MG362x1A signal generator features on-site level calibration capability built in to the instrument. The on-site power calibration is accomplished at the touch of a button on the GUI interface. When customers want to ensure level accuracy of the instrument, it can be done without ever sending the instrument to a calibration lab. This saves time and cost for the customer and increases instrument availability.



Rubidium MG362x1A Signal Generator Connected to a MA243xxA Power Sensor

The on-site level cal calibrates the RF power level accuracy to -60 dBm.

An Anritsu power sensor is needed for on-site level calibration of Rubidium signal generator.

Equipment Required

- USB Power Sensor MA24330A (10 MHz to 33 GHz). Best when calibrating a MG26221A.
- USB Power Sensor MA24350A (10 MHz to 50 GHz). Best when calibrating an MG36241A.
- 20 dB fixed attenuation pad supplied with the required kit #2000-xxx-xxx.

Elegant and Easy to Navigate Touch Screen Interface

The Rubidium MG362x1A signal generator front panel has a 7-inch touch screen along with traditional keypad and rotary dial interface that satisfies needs of a wide diversity of customers.

The graphical user interface is designed such that essential information about the state of the instrument and most important settings are always visible to the user at the top. The navigation through various menus is intuitive and streamlined such that the user can set the parameters with minimum number of touches or key presses.

The GUI has several features that enable the user to quickly and efficiently set up the signal generator for measurement. The user can set up a range of frequency, level, and sweep presets and recall them with a single touch. On many parameter setting screens, the user can reset parameters with a single touch.

The touch screen interface can be controlled using a keyboard attached to the USB 3.0 ports on the front panel. In addition, the signal generator can be controlled over Ethernet with a remote GUI interface hosted on a Windows laptop or a PC.

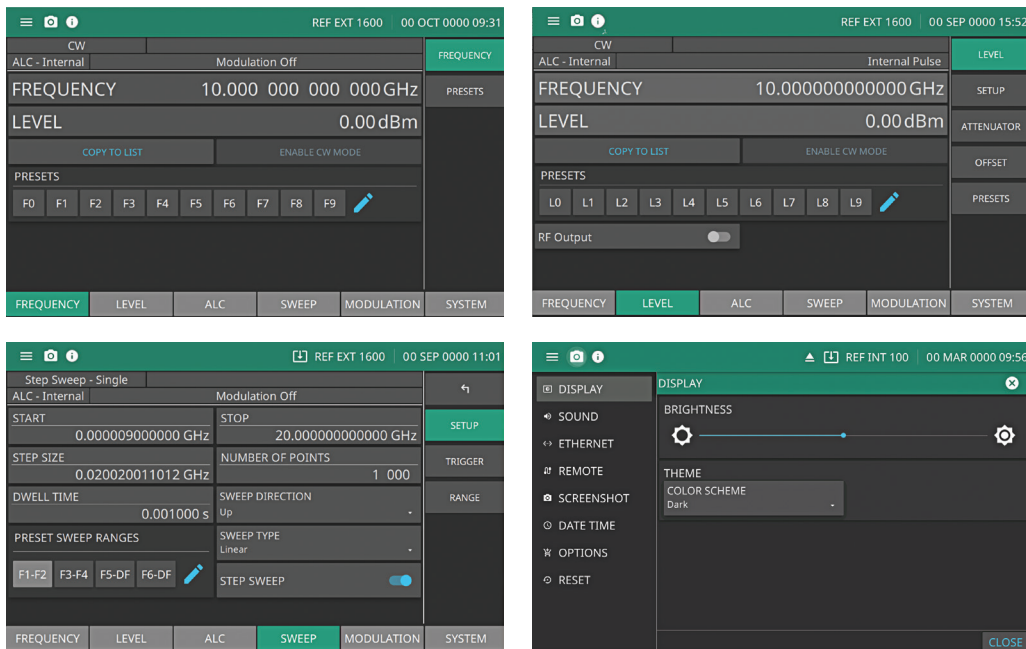

Complex Analog Modulation Signals

The Rubidium MG362x1A signal generator features extensive internal waveform generation capabilities. Seven different waveform types can be generated internally and can be used to modulate the carrier in AM/FM/PM modes:

- Sine waves
- Square waves
- Positive/negative going ramps
- Triangles
- Gaussian noise
- Uniform noise
- Pulse and Pulse train

Simultaneous modulation of AM/FM, AM/PM, and synchronized FM/Pulse modulation are possible. This enables generation of complex modulation waveforms such as chirps.

The Rubidium MG362x1A signal generator provides modulation input connectors on the front panel as an option. This feature minimizes distortion of external modulation inputs such as narrow pulses due to use of long cables.

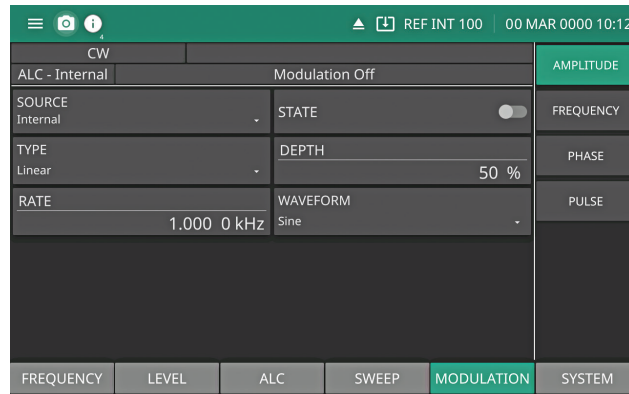

Rubidium MG36271A Signal Generator Key Specifications

Parameter	Specification
Frequency Range	9 kHz to 20/43.5 GHz/70 GHz Operable up to 72 GHz
Frequency Resolution	0.001 Hz
Phase Offset	Adjustable in 0.1 degree steps
SSB Phase Noise	-136 dBc/Hz (typical) and -140 dBc/Hz (measured) at 10 GHz output, 10 kHz offset
Internal Time Base Stability – Aging	- Aging: $\pm 2 \times 10^{-8}$ per year with Option 3
Reference Frequency Input/Output	10 MHz, 100 MHz, 1600 MHz
Output Power	-130 dBm to +20 dBm (20 GHz standard output) -130 dBm to +16 dBm (43.5 GHz, standard output) -100 dBm to +6 dBm (70 GHz, standard output)
Level Accuracy and Flatness	± 1.4 dB (MG36221A/MG36241A) ± 2.5 dB (MG36271A)
Harmonics (20/43.5/70 GHz)	-58 dBc (MG36221A) -55 dBc (MG36241A and MG36271A)
Sub Harmonics	-83 dBc (MG36221A and MG36241A) -63 dBc (MG36271A)
Non Harmonics (20/43.5/70 GHz)	-63 dBc
Modulation	AM, FM, PM, and Pulse
Pulse Modulation: Min Pulse Width	<math>< 50</math> ns (unleveled)
Pulse Modulation: Rise/Fall Times	5 ns (typical)
LF Signal Generator Waveforms	Sine, square, pulse, triangle, ramp, GN/UN noise
Frequency Sweep Modes	Step, List, Analog
Frequency Sweep Width	9 kHz to full frequency range (step, list) 100 MHz to full frequency range (Analog)
Power Sweep	Step, List
Power Sweep Resolution	0.01 dB/step

Application Use Cases for Rubidium MG362x1A Signal Generator

- Making nonlinear measurements
 - Single tone distortion – P1 dB compression point
 - Two tone intermodulation – IP2, IP3
 - In-band and out-of-band interference (C/I, blocking)
- As signal source to test devices and systems
 - Pulse modulated signal source to test radar systems
 - As pure CW source for LO substitution in testing of transceiver chains
 - Clock and CW source for testing Gbit data converters analog-to-digital converter and digital-to-analog converter (ADC and DAC)
- Making swept linear measurements
 - As additional sources synchronized with vector network analyzer
- As frequency reference in calibration and metrology labs

Interfaces

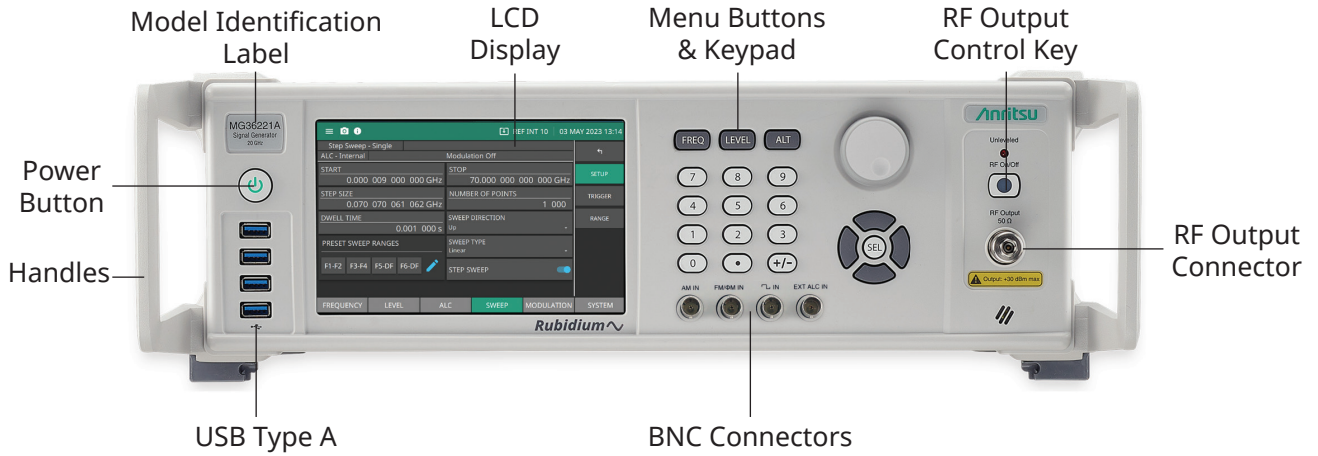

Rubidium MG362x1A Signal Generator Front Panel

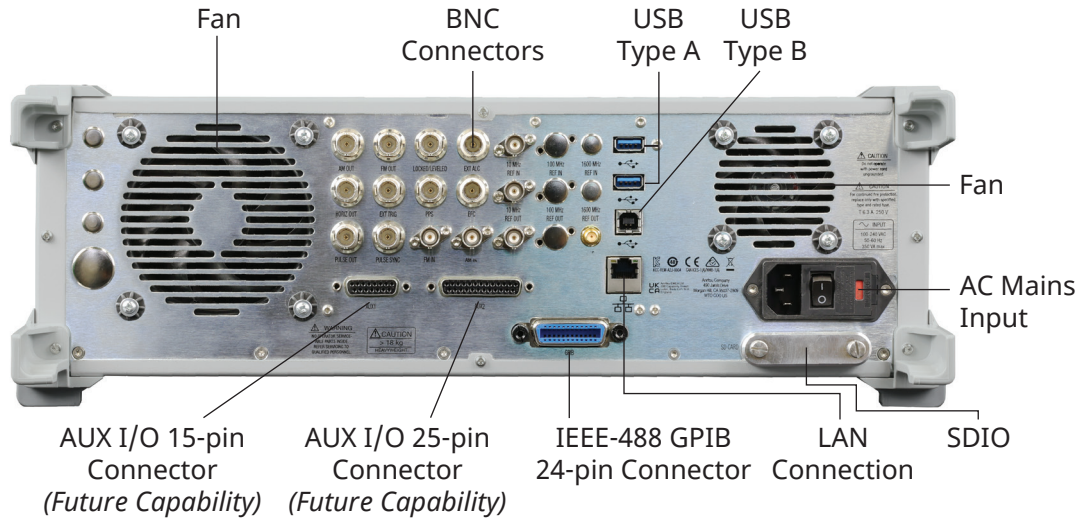

Rubidium MG362x1A Signal Generator Back Panel

Inputs and Outputs

Description **Connectors may be available but not active if the option is not ordered.**

AM OUT	Provides the amplitude modulation waveform from the internal LF generator. Enabled with Option 27. BNC type, rear panel.
HORIZ OUT	Requires Option 6 (available for MG36221A only). Horizontal Sweep Output provides a 0 V at beginning and +10 V at end of sweep for all sweep modes, regardless of sweep width. In CW mode, the voltage is proportional to frequency between 0 V at low end and +10 V at the high end of range. In CW mode, if CW Ramp is enabled, a repetitive 0 V to +10 V ramp is provided. The ramp speed is adjusted by the Sweep Time function. BNC type, rear panel.
PULSE OUT	Provides a video modulating signal from the internal pulse generator. Enabled with Option 27. BNC type, rear panel.
FM OUT	Provides the frequency or phase modulation waveform from the internal LF generator. Enabled with Option 27. BNC type, rear panel.
EXT TRIG	External Trigger accepts a TTL low-level signal of 1 μ s width to trigger a sweep. BNC type, rear panel.
PULSE SYNC	Provides a TTL compatible signal, synchronized to the internal pulse modulation output. Enabled with Option 26. BNC type, rear panel.
LOCKED/LEVELED	TTL high/low output signal when in internal ALC mode that is a logical AND of frequency locked condition and output leveled condition. When in Fixed Gain mode this signal indicates only frequency locked/unlocked condition. BNC type, rear panel.
PPS	1PPS input/output from either GNSS/GPS atomic clock receiver or internal rubidium reference option. 3.3V CMOS I/O. BNC type, rear panel.
FM IN	Accepts an external signal to frequency or phase modulate the RF output signal. Enabled with Option 12. 50 Ω impedance. BNC type, rear panel.
EXT ALC	Provides for leveling the RF output signal externally with either a detector or power meter. Signal requirements are shown in the RF Output specifications. BNC type, rear panel.
EFC	± 4 VDC 30 Hz bandwidth in wide reference PLL mode 1 MEG Ohm input impedance. Provides the capability to frequency modulate the internal crystal oscillator, allowing phase locking of the synthesizer inside an external lock loop. BNC type, rear panel.
AM IN	Accepts an external signal to amplitude modulate the RF output signal. Enabled with Option 12. 50 Ω impedance. BNC type, rear panel.
10 MHZ REF IN	Accepts an external 10 MHz \pm 3 Hz, 0 dBm to +10 dBm (20 dBm no-damage level) time-base signal. Automatically disconnects the internal high-stability time-base option, if connected. 50 Ω impedance BNC type, rear panel
10 MHZ REF OUT	Provides a 10 dBm, AC coupled, signal derived from the internal frequency standard. 50 Ω impedance BNC type, rear panel.
PULSE IN	Accepts an external TTL compatible signal to pulse modulate the RF output signal or to trigger or to gate the optional internal pulse generator. Enabled with Option 26. BNC type, rear panel.

Inputs and Outputs

100 MHZ REF IN	Accepts an external 100 MHz \pm 200 Hz or 2 ppm 12 \pm 1 dBm (20 dBm no-damage level) reference signal. Enabled with Option 3 or 13. Automatically disconnects the internal high-stability, time-base option, if connected. 50 Ω impedance BNC type, rear panel.
100 MHZ REF OUT	Provides a 12 dBm, AC coupled, 100 MHz signal derived from the internal frequency standard. Enabled with Option 3 or 13. 50 Ω impedance BNC type, rear panel.
1600 MHZ REF IN	Accepts an external 1600 MHz \pm 3.2 kHz or 2 ppm, 4 \pm 1 dBm (20 dBm no-damage level) reference signal. Enabled with Option 3 or 13. Automatically disconnects the internal high-stability time-base option, if connected. 50 Ω impedance SMA type, rear panel.
1600 MHZ OUT	Provides a 5 dBm, AC coupled, 1600 MHz signal derived from the internal frequency standard. Enabled with Option 3 or 13. 50 Ω impedance SMA type, rear panel.
GPS	Accepts GNSS/GPS antenna input. Requires Option 66.
RF OUTPUT	Provides for RF output from 50 Ω source impedance. Option 9 moves the RF Output connector from the front to the rear panel. K Connector (male) $f_{max} \leq 43.5$ GHz. V Connector (male) $f_{max} 70$ GHz.
ETHERNET (1000 Base-T)	Provides input/output connections for a Gigabit Ethernet interface. Accepts RJ45 type connectors, rear panel.
GPIB (IEEE-488)	Provides input/output connections for the General Purpose Interface Bus.
USB	Two USB 3.0 Type-A for peripherals such as memory device.
SD CARD	Accepts an external SDIO memory card.
AC POWER INPUT	AC Input connector, with On/Off switch, and fuses 350 VA maximum, 90 to 264 VAC, 47 Hz to 63 Hz.
AUX 1	Future capability
AUX 2	Future capability

Ordering Information

Part Number	Description
MG36221A	Signal Generator 9 kHz to 20 GHz
MG36221A-0001	Rack Mount with Slides (cannot be ordered with Option 11)
MG36221A-0002	Mechanical Step Attenuator, 110 dB
MG36221A-0003	Low Phase Noise and High Stability
MG36221A-0006	Analog Sweep, Frequency
MG36221A-0009	Rear Panel K(m)-Connector RF Output
MG36221A-0010	User Defined Modulation (requires Option 12, 26 and 27)
MG36221A-0011	Rack Mount without Slides (shelf mount)
MG36221A-0012	Amplitude, Frequency, and Phase Modulation, Internal/External (requires Option 27)
MG36221A-0013	Ultra Low Phase Noise (requires Option 3)
MG36221A-0015	High Power Output
MG36221A-0018	On-site User Level Calibration (Requires 2000-2166-R accessory kit and MA243x0A USB power sensor, sold separately)
MG36221A-0023	Premium Phase Noise, CW (requires Option 3 and 13)
MG36221A-0025	Pulse Train Modulation (requires Option 12, 26 and 27)
MG36221A-0026	Pulse Modulation, Internal/External (requires Option 27)
MG36221A-0027	Modulation Hardware (requires Option 12 or 26, or both)
MG36221A-0029	Front Panel Modulation Input Output Access (Option 27 required when ordering Option 12 or 26, or both)
MG36221A-0030	600 Ohms External AM/FM Input Impedance (requires Option 12 and 27)
MG36221A-0033	Phase Noise, Export Option (cannot be ordered with Options 3, 13, 23, and 56)
MG36221A-0037	Removable SDIO Memory
MG36221A-0056	Ultra Stability Time Base (requires Option 3 or 13)
MG36221A-0066	GNSS Atomic Clock Receiver (requires Option 3 or 13)
MG36221A-0097	Accredited Calibration to ISO17025 and ANSI/NCSL Z540-1, includes calibration certificate, test report, and uncertainty data
MG36221A-0098	Standard Calibration to ISO17025 and ANSI/NCSL Z540-1, includes calibration certificate
MG36221A-0099	Premium Calibration to ISO17025 and ANSI/NCSL Z540-1, includes calibration certificate, test report, and uncertainty data
MG36241A	Signal Generator, 9 kHz to 43.5 GHz
MG36241A-0001	Rack Mount with Slides (cannot be ordered with Option 11)
MG36241A-0002	Mechanical Step Attenuator, 110 dB
MG36241A-0003	Low Phase Noise and High Stability
MG36241A-0006	Analog Sweep, Frequency
MG36241A-0009	Rear Panel K(m)-Connector RF Output
MG36241A-0010	User Defined Modulation (requires Option 12, 26 and 27)
MG36241A-0011	Rack Mount without Slides (shelf mount)
MG36241A-0012	Amplitude, Frequency, and Phase Modulation, Internal/External (requires Option 27)
MG36241A-0013	Ultra Low Phase Noise (requires Option 3)
MG36241A-0015	High Power Output
MG36241A-0018	On-site User Level Calibration (requires 2000-2166-R accessory kit and MA243x0A USB power sensor, sold separately)
MG36241A-0025	Pulse Train Modulation (requires Option 26 and 27)
MG36241A-0026	Pulse Modulation, Internal/External (requires Option 27)
MG36241A-0027	Modulation Hardware (requires Option 12 or 26, or both for functionality)
MG36241A-0029	Front Panel Modulation Input Output Access (Option 27 required when ordering Option 12 or 26, or both)
MG36241A-0030	600 Ohms External AM/FM Input Impedance (requires Option 12 and 27)
MG36241A-0033	Phase Noise, Export Option (cannot be ordered with Options 3, 13, and 56)
MG36241A-0037	Removable SDIO Memory
MG36241A-0056	Ultra Stability Time Base (requires Option 3 or 13)
MG36241A-0066	GNSS Atomic Clock Receiver (requires Option 3 or 13)
MG36241A-0097	Accredited Calibration to ISO17025 and ANSI/NCSL Z540-1, includes calibration certificate, test report, and uncertainty data
MG36241A-0098	Standard Calibration to ISO17025 and ANSI/NCSL Z540-1, includes calibration certificate
MG36241A-0099	Premium Calibration to ISO17025 and ANSI/NCSL Z540-1, includes calibration certificate, test report, and uncertainty data
MG36271A	Signal Generator, 9 kHz to 70 GHz
MG36271A-0001	Rack Mount with Slides (cannot be ordered with Option 11)
MG36271A-0002	Mechanical Step Attenuator, 90 dB
MG36271A-0003	Low Phase Noise and High Stability
MG36271A-0010	User Defined Modulation (requires Option 12, 26 and 27)
MG36271A-0011	Rack Mount without Slides (shelf mount)
MG36271A-0012	Amplitude, Frequency, and Phase Modulation, Internal/External (requires Option 27)
MG36271A-0013	Ultra Low Phase Noise (requires Option 3)
MG36271A-0015	High Power Output
MG36271A-0025	Pulse Train Modulation (requires Option 26 and 27)
MG36271A-0026	Pulse Modulation, Internal/External (requires Option 27)
MG36271A-0027	Modulation Hardware (requires Option 12 or 26, or both for functionality)
MG36271A-0029	Front Panel Modulation Input Output Access (Option 27 required when ordering Option 12 or 26, or both)
MG36271A-0030	600 Ohms External AM/FM Input Impedance (requires Option 12 and 27)
MG36271A-0033	Phase Noise, Export Option (cannot be ordered with Options 3, 13, and 56)
MG36271A-0037	Removable SDIO Memory
MG36271A-0056	Ultra Stability Time Base (requires Option 3 or 13)
MG36271A-0066	GNSS Atomic Clock Receiver (requires Option 3 or 13)
MG36271A-0097	Accredited Calibration to ISO17025 and ANSI/NCSL Z540-1, includes calibration certificate, test report, and uncertainty data
MG36271A-0098	Standard Calibration to ISO17025 and ANSI/NCSL Z540-1, includes calibration certificate
MG36271A-0099	Premium Calibration to ISO17025 and ANSI/NCSL Z540-1, includes calibration certificate, test report, and uncertainty data

• **United States**

Anritsu Americas Sales Company

490 Jarvis Drive, Morgan Hill, CA 95037-2809, U.S.A.
Phone: +1-800-Anritsu (1-800-267-4878)

• **Canada**

Anritsu Electronics Ltd.

Americas Sales and Support

490 Jarvis Drive, Morgan Hill, CA 95037-2809, U.S.A.
Phone: +1-800-Anritsu (1-800-267-4878)

• **Brazil**

Anritsu Eletronica Ltda.

Praça Amadeu Amaral, 27 - 1 Andar
01327-010 - Bela Vista - Sao Paulo - SP, Brazil
Phone: +55-11-3283-2511
Fax: +55-11-3288-6940

• **Mexico**

Anritsu Company, S.A. de C.V.

Blvd Miguel de Cervantes Saavedra #169 Piso 1, Col. Granada
Mexico, Ciudad de Mexico, 11520, MEXICO
Phone: +52-55-4169-7104

• **United Kingdom**

Anritsu EMEA Ltd.

200 Capability Green, Luton, Bedfordshire, LU1 3LU, U.K.
Phone: +44-1582-433200
Fax: +44-1582-731303

• **France**

Anritsu S.A.

12 avenue du Québec, Immeuble Goyave,
91140 VILLEBON SUR YVETTE, France
Phone: +33-1-60-92-15-50

• **Germany**

Anritsu GmbH

Nemetschek Haus, Konrad-Zuse-Platz 1,
81829 München, Germany
Phone: +49-89-442308-0
Fax: +49-89-442308-55

• **Italy**

Anritsu S.r.l.

Spaces Eur Arte, Viale dell'Arte 25, 00144 Roma, Italy
Phone: +39-6-509-9711

• **Sweden**

Anritsu AB

Kistagången 20 B, 2 tr, 164 40 Kista, Sweden
Phone: +46-8-534-707-00

• **Finland**

Anritsu AB

Technopolis Aviapolis, Teknobulevardi 3-5 (D208.5.),
FI-01530 Vantaa, Finland
Phone: +358-20-741-8100

• **Denmark**

Anritsu A/S

c/o Regus Winghouse, Ørestads Boulevard 73, 4th floor,
2300 Copenhagen S, Denmark
Phone: +45-7211-2200

• **Spain**

Anritsu EMEA GmbH

Representation Office in Spain

Calle Manzanares 4, Primera planta, 28005 Madrid, Spain
Phone: +34-91-572-6761

• **Austria**

Anritsu EMEA GmbH

Am Belvedere 10, A-1100 Vienna, Austria
Phone: +43-(0)1-717-28-710

• **United Arab Emirates**

Anritsu A/S

Office No. 164, Building 17, Dubai Internet City
P. O. Box – 501901, Dubai, United Arab Emirates
Phone: +971-4-3758479

• **India**

Anritsu India Private Limited

6th Floor, Indique ETA, No.38/4, Adjacent to EMC2,
Doddanekundi, Outer Ring Road, Bengaluru – 560048, India
Phone: +91-80-6728-1300
Fax: +91-80-6728-1301

• **Singapore**

Anritsu Pte. Ltd.

1 Jalan Kilang Timor, #07-04/06 Pacific Tech Centre
Singapore 159303
Phone: +65-6282-2400
Fax: +65-6282-2533

• **Vietnam**

Anritsu Company Limited

16th Floor, Peakview Tower, 36 Hoang Cau Street, O Cho Dua Ward,
Dong Da District, Hanoi, Vietnam
Phone: +84-24-3201-2730

• **P.R. China (Shanghai)**

Anritsu (China) Co., Ltd.

Room 2701-2705, Tower A, New Caohejing International
Business Center No. 391 Gui Ping Road Shanghai, 200233, P.R. China
Phone: +86-21-6237-0898
Fax: +86-21-6237-0899

• **P.R. China (Hong Kong)**

Anritsu Company Ltd.

Unit 1006-7, 10/F., Greenfield Tower, Concordia Plaza,
No. 1 Science Museum Road, Tsim Sha Tsui East,
Kowloon, Hong Kong, P.R. China
Phone: +852-2301-4980
Fax: +852-2301-3545

• **Japan**

Anritsu Corporation

8-5, Tamura-cho, Atsugi-shi, Kanagawa, 243-0016 Japan
Phone: +81-46-296-6509
Fax: +81-46-225-8352

• **Korea**

Anritsu Corporation, Ltd.

8F, A TOWER, 20, Gwacheondaero 7-gil, Gwacheon-si,
Gyeonggi-do, 13840, Republic of Korea
Phone: +82-2-6259-7300
Fax: +82-2-6259-7301

• **Australia**

Anritsu Pty. Ltd.

Unit 20, 21-35 Ricketts Road, Mount Waverley, Victoria 3149, Australia
Phone: +61-3-9558-8177
Fax: +61-3-9558-8255

• **Taiwan**

Anritsu Company Inc.

7F, No. 316, Sec. 1, NeiHu Rd., Taipei 114, Taiwan
Phone: +886-2-8751-1816
Fax: +886-2-8751-1817

List Revision Date: 20240416



Anritsu utilizes recycled paper and environmentally conscious inks and toner.



© Anritsu All trademarks are registered trademarks of their respective owners. Data subject to change without notice. For the most recent specifications visit: www.anritsu.com